

ES1686dc

Enterprise-Class Storage



High Efficiency

Data reduction technology



High Availability

Active-active controller architecture



Ensured Data Integrity

ZFS file system

Hardware Architecture

Intel Xeon D-2100 series processor

Provides the performance needed for enterprise-level storage and mission-critical applications.

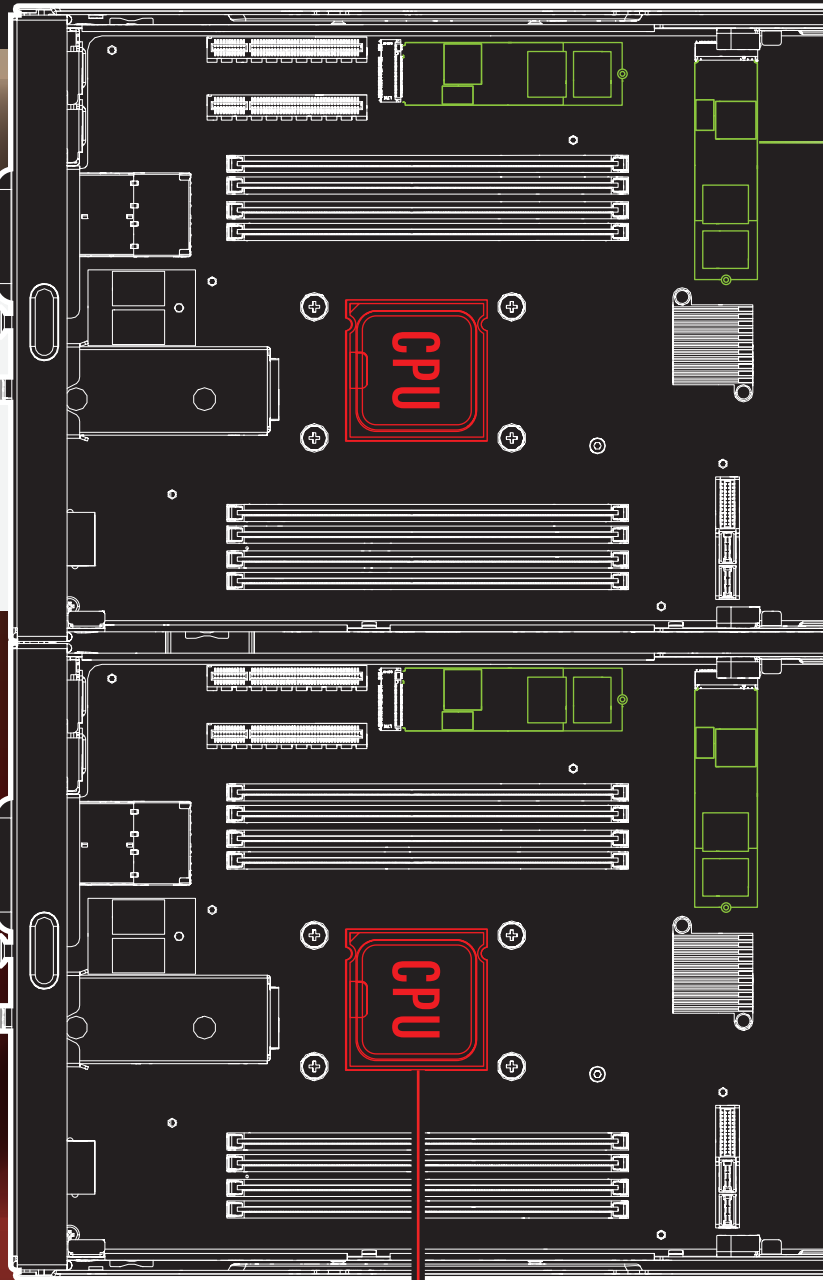

Built-in 10GbE SFP+ network interface

4x 10 GbE (SFP+) ports satisfy iSCSI, NFS, CIFS, and other data transmission needs.

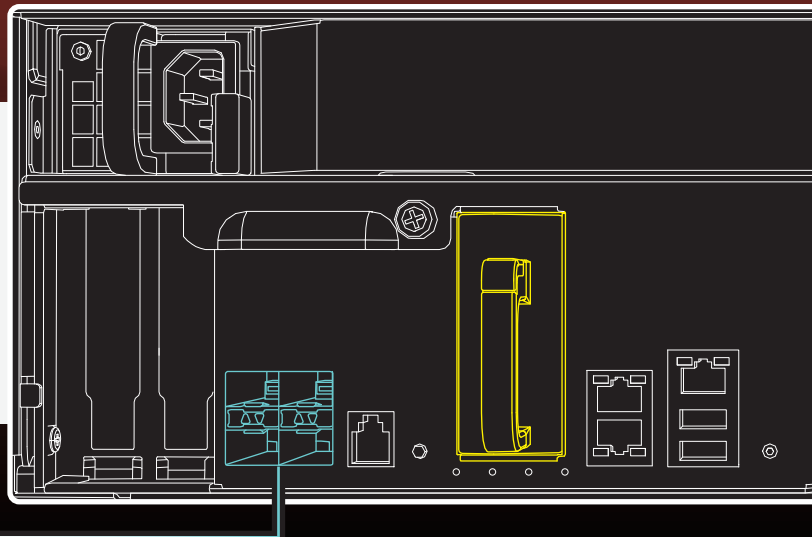

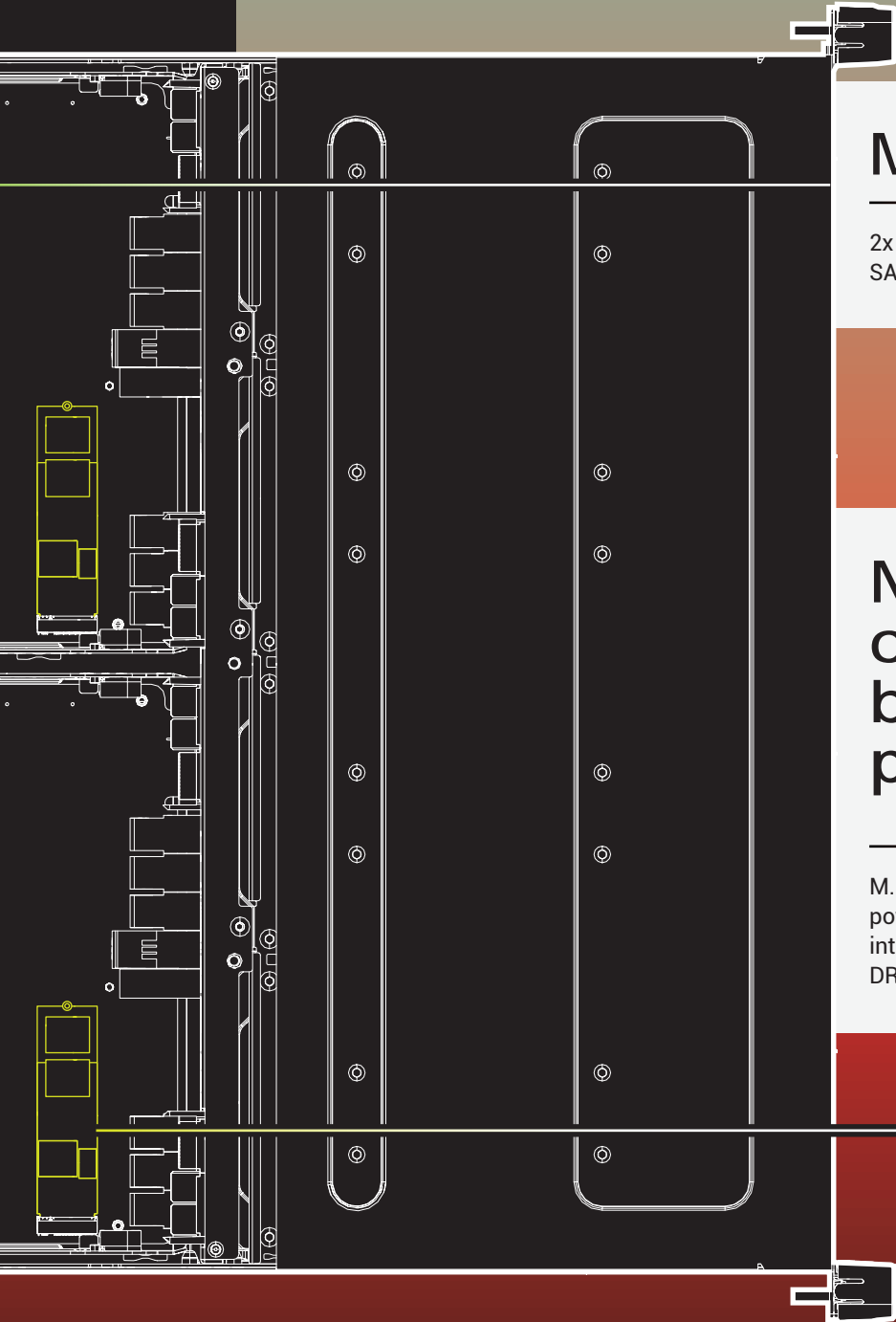

M.2 SSD slot

2x M.2 SSD slots for read acceleration. Supports SATA 6Gb/s or NVMe Gen3 x4 2280 SSDs.

NVRAM write cache with battery data protection

M.2 SSD for copy-to-flash (C2F) backup. If a power outage occurs, the system ensures data integrity by moving write cache data from DRAM to M.2 SSD using BBU power.

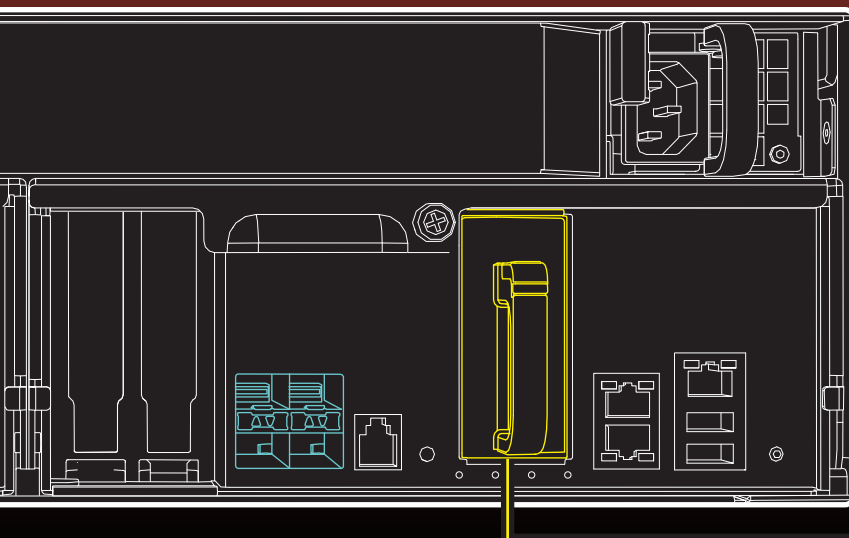

Battery Backup Unit (BBU)

The hot-swappable battery provides sufficient power to maintain NVRAM during power outages.

Software Architecture

Excellent random read/write performance

SSD Cache allows the client to accelerate read performance on HDD-based storage pools. While write coalescing assists in transferring random writes to sequential writes to provide industry-leading performance.

QES system

Controller A

File Service

SMB
NFS
FTP

iSCSI Service

VSS
ODX
MPIO
ALUA

- Immune to power failure
- No silent data corruption

See page 6

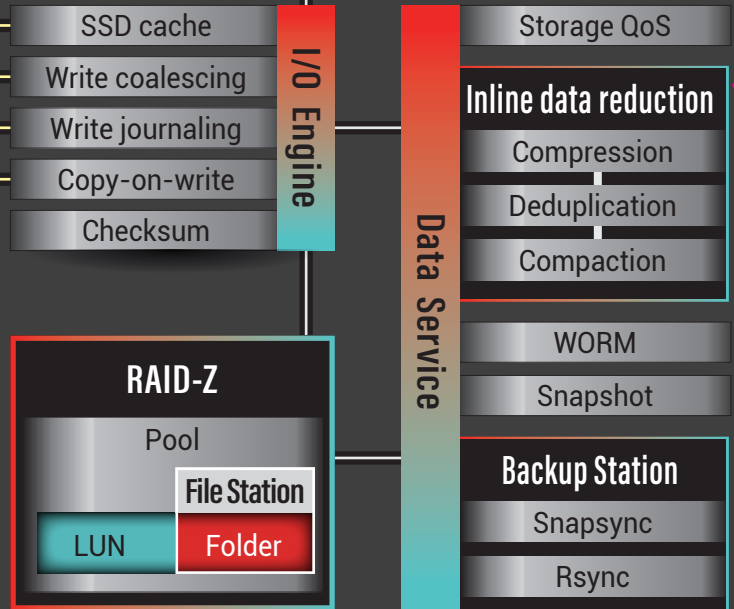

RAID-Z supports triple-parity protection for large-capacity drives

Triple-parity RAID provides more protection for the system to finish rebuilding the array, which is especially useful for restoring high-capacity disks.

High availability

The active-active controller architecture can withstand a single point of failure to ensure business continuity. The two controllers constantly synchronize write data and system status and are always ready to takeover in the event of controller failure.

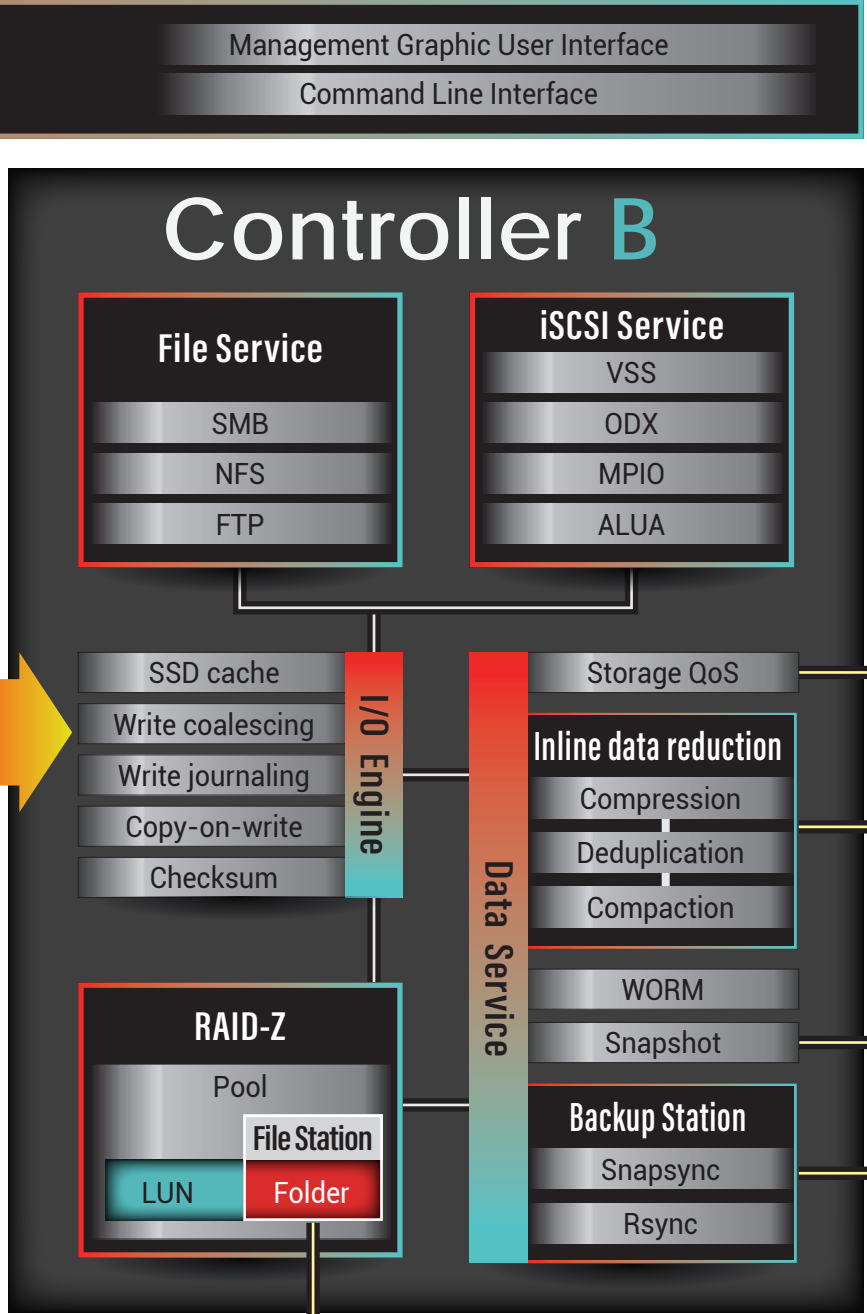
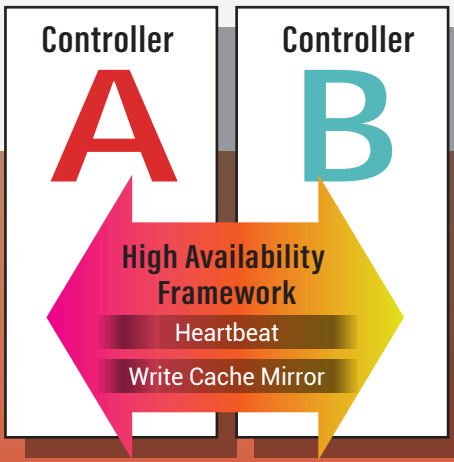

- Solves the "Noisy Neighbor" effect
 - Enhanced SSD lifespan
 - Robust data protection
- See pages 7 and 8

File management with a visualized interface

Files are easily managed using the QES File Station.

Built for mission-critical applications, the QNAP ES1686dc features ZFS, dual-active controllers, and a user-friendly GUI to provide users with ensured data integrity, high availability, and excellent performance.

Redundant controllers ensure high availability

The redundant-controller design of the ES1686dc ensures uninterrupted operations. As the cache memory between the two controllers is continuously synchronizing with each other, if one of the controllers fails, the data written in cache memory can still be written to disks to ensure data integrity.

Performance elasticity with active-active controller mechanisms

To ensure sufficient system resources during an unexpected controller failure, it is recommended to keep controller workloads at 50%. This configuration can then use the remaining system resources to reinforce performance-demanding applications during peak usage times.

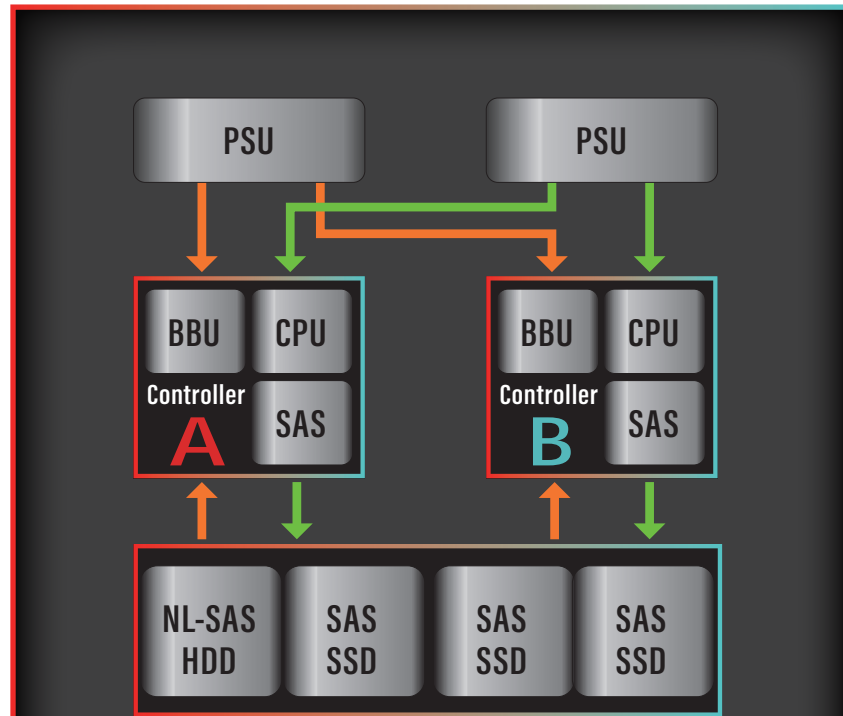

ES1686dc

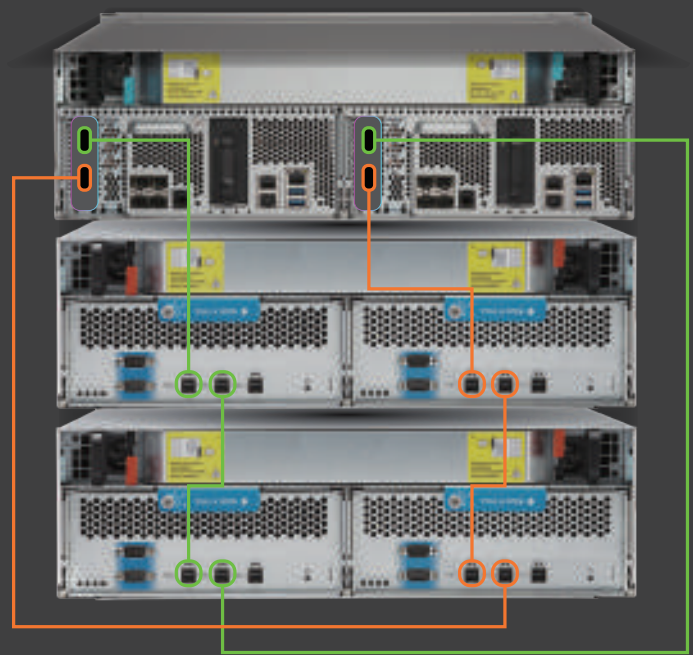

Robust data integrity with ZFS

ZFS is built to ensure data integrity, and features mechanisms suited for enterprise-level storage solutions.

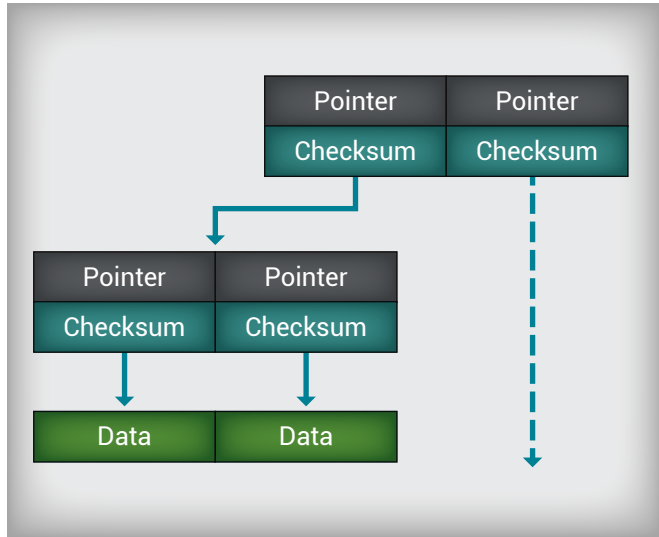

Protects against silent data corruption

Self-Healing

Within ZFS, each block of data is checksummed. When reading a RAID-Z block, ZFS compares it against its checksum, and if the data disks did not return the right answer, ZFS reads the parity and then figures out which disk returned bad data. Then, it repairs the damaged data and returns good data to the requestor, thus preventing silent data corruption.

Immune to power failure

Write Journaling

ZFS tracks file changes not-yet-committed to the file system by recording the intentions of such changes in its data structure. In the event of a system crash or power failure, ZFS checks the journal logs and then applies the scheduled changes, enabling the file system to be brought back online more quickly with a lower likelihood of becoming corrupted.

Copy-On-Write (COW)

ZFS uses a copy-on-write transactional object model. Blocks containing active data are never overwritten in place; instead, a new block is allocated, modified data is written to it, then any metadata blocks referencing it are similarly read, reallocated, and written. By operating with write journaling, the copy-on-write model ensures that users can still find the most-recent data before the latest write operation.

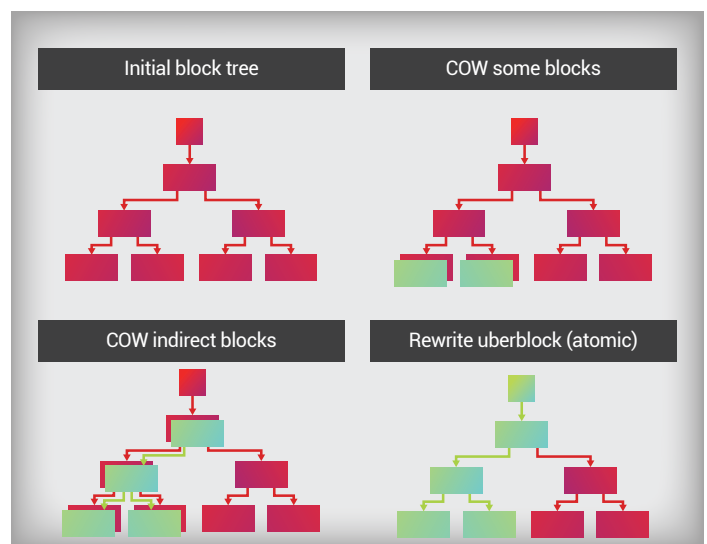

Efficient data reduction with inline compression, deduplication, and compaction

The QNAP ES family features data reduction technology, making it especially useful for all-flash storage arrays.

Reduce Storage Footprint

Every read-modify-write operation consumes the life of a flash cell. Inline data compression is being used to reduce the size of the data set to be stored. Data compaction stores multiple user data blocks and files within a single 4 KB block. Without data compaction, each file would get its own 4 KB block, consuming more 4KB blocks for the same amount of data. Inline deduplication then checks new data ready to be sent to storage against data that already exists in storage and doesn't store any of the redundant data it discovers. By minimizing the amount of physical blocks allocated for data storage, QNAP's data reduction technology helps to further extend the lifespan of users' SSDs - allowing the utilization of more cost-efficient SSDs without worrying about flash-cell wear-out.

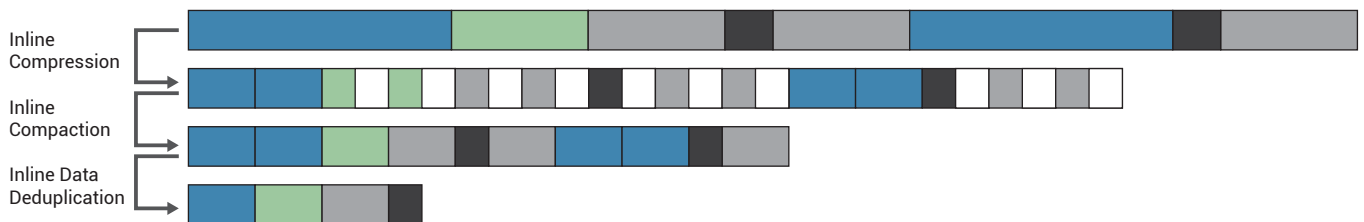

Robust Performance Optimization

Performance optimization- Write coalescing

Write coalescing is a mechanism that transfers random writes (small blocks) into sequential writes (large blocks), which reduces the times of writes on drives. In an all-flash configuration, reduced write times result in minimized garbage collection, therefore minimizing the effect of write amplification.

Supports NVMe SSD as system read cache

The ES1686dc has two M.2 NVMe slots on each controller, and supports the QM2 adapter (four M.2 SSDs on a single PCIe card). These SSDs can be configured as system read cache to improve total performance without occupying drive bays.

Use cost-efficient QNAP Drive Adapters to boost system performance

The QNAP Drive Adapter (QDA) allows users to install SATA disks on dual controller models. This enables users to utilize cost-efficient SATA SSDs on the dual-controller ES1686dc system for all-flash configurations and SSD Cache.

Storage QoS

The ES1686dc is a powerful storage system that is capable of serving multiple applications in a single array. This raises the concern of the "Noisy Neighbor" effect where low-priority applications consume the resources necessary for more-important services. Storage QoS allows users to define the priority of every application running on the array by setting the system resources that should be allocated for LUNs and Shared Folders.

Snapshot and SnapSync

QNAP NAS snapshots store differential datasets from folders and iSCSI LUNs with no performance impact. Snapshots can be further replicated to another QES system by using QNAP's SnapSync technology.

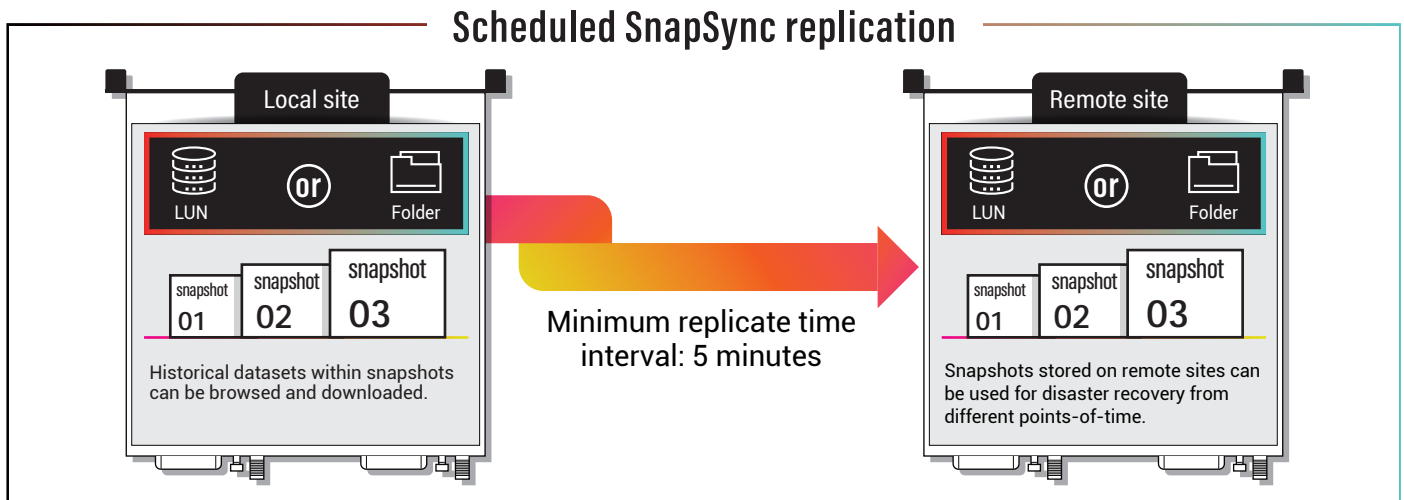

SnapSync creates either a real-time or a scheduled replication job between two QES systems. Disaster recovery can be performed through remote replication to minimize the impact from site failure, as data can be immediately retrieved from the remote backup site.

QES Backup Station allows browsing snapshot content, allowing users to download historical datasets without remounting the entire shared folder.

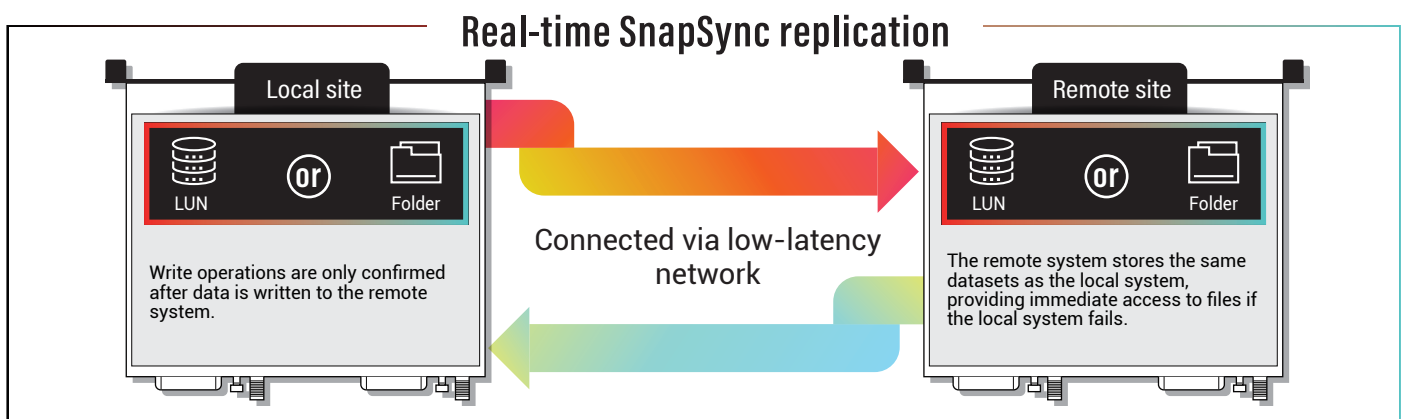

WORM folder

With increasingly stringent regulations on how information is stored, many countries require government agencies, financial institutions, and healthcare providers to comply with strict data archiving regulations. To meet the security requirements of enterprise storage, the QNAP ES Series NAS has WORM functionality to help users protect important organizational information. WORM (Write Once, Read Many) is used to avoid modification of saved data. After this feature is enabled, data in shared folders can only be written, and cannot be deleted or modified to ensure data integrity. WORM folders can be deployed on thin-provisioning pools for future expansion flexibility as well as being configured with folder quotas for capacity management. Data reduction technology can also be applied to optimize storage utilization.

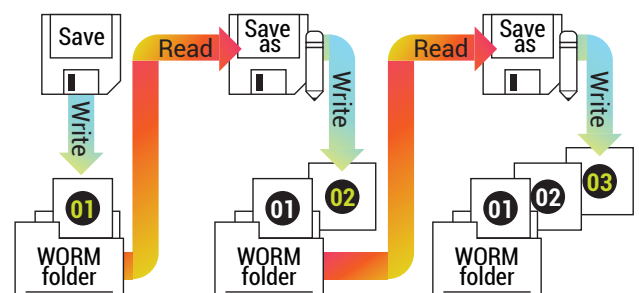

- Data cannot be deleted from the file system.
- Supports data retention periods and indefinite data retention.

Hardware Specification

	ES1686dc-2123IT-64G	ES1686dc-2145NT-96G	ES1686dc-2145NT-128G
Form Factor	3U		
Processor	Intel Xeon D 4-core 2.2GHz	Intel Xeon D 8-core 1.9GHz	Intel Xeon D 8-core 1.9GHz
Memory	64GB	96GB	128GB
Max. Memory	1TB		
Memory slots	16 (DDR4, RDIMM/LRDIMM)		
Drive bays	16 x 3.5-inch SAS/SATA		
M.2 SSD slots	4 (supports SATA 6Gb/s or NVMe Gen3 x4 2280)		
SSD cache	Yes		
Copy to Flash battery	12v, 2200mAh		
Management ports	1 per controller		
On-board network ports	4x 1GbE (RJ45) 8x 10GbE (SFP+)		
PCIe slots	4 (Gen3x8)		
USB ports	4 (USB3.0)		
Dimensions (mm)	132 x 483.05 x 630.62 mm		
Weight (kg)	32.69 kg (Gross) ; 25.83 kg (Net)		
Temperature	0 - 40 °C (32°F - 104°F)		
Relative humidity	5% - 95%		
Power supply	90~264VAC; 770W		
Power consumption	Normal 500.87W		
Noise	55.8 db		

Expansion Enclosure Specifications

	EJ1600v2	EJ1600
Form Factor	3U rackmount	
Host Interface	SAS 12Gbps	SAS 6Gbps
Dimensions	132 × 446.2 × 618 mm	
Weight (Net)	33.76 kg (Gross), 24.11 kg (Net)	
Drive slots	16 x 3.5-inch SAS/SATA	
Temperature	0 - 40 °C (32°F - 104°F)	
Relative Humidity	5~95% RH non-condensing, wet bulb: 27°C.	
Power Supply	2x 450W, 90-240Vac~, 50-60Hz	
Power Consumption	Normal: 344.19 W	
Sound Level	53.5 db(A)	

Network Expansion Cards

Brand	Model	Description
QNAP	LAN-10G2T-X550	Dual-port (10GBASE-T) 10GbE network expansion card
Mellanox	MCX312B-XCCT	Dual-port (SFP+) 10GbE network expansion card
Mellanox	MCX314A-BCCT	Dual-port (QSFP) 40/56GbE network expansion card
Mellanox	MCX313A-BCCT	Single-port (QSFP) 40/56GbE network expansion card
Mellanox	MCX311A-XCCT	Single-port (SFP+) 10GbE network expansion card
QNAP	LAN-40G2SF-MLX	Dual-port (QSFP+) 40GbE network expansion card
QNAP	LAN-10G2SF-MLX	Dual-port (SFP+) 10GbE network expansion card

Software Specification

High Availability	Security	Thirty Party Plug-ins
Active-active dual controller for NAS	Network access protection with auto-blocking: SSH, HTTP(S), FTP, CIFS/SMB	SMI-S Provider
Active-active dual controller for JBOD expander	CIFS/SMB host access control for shared folders	vSphere Web Client Plugin
MPIO for iSCSI high availability	FIPS 140-2 validated AES 256-bit volume-based and shared folder data encryption	VAAI Plug-in: NFS, iSCSI
Firmware update without interrupting service	Importable SSL certificates	VMware Storage Replication Adapter (SRA)
Link aggregation for network high availability	Instant alert via E-mail, SMS, beep	QNAP Cinder Driver for Openstack block storage
Supported Client OS	Storage Management	QNAP Manila Driver for Openstack shared file storage
Windows 7 (32/64-bit), Windows 8 (32/64-bit), Windows 10 (32/64-bit), Windows Server 2008 R2/2012/2012R2/2016	Storage space utilization monitoring	Power Management
Apple Mac OS X	Storage pool with RAID 0, 1, 5, 6, 10, 50, 60, RAID TP, triple mirror	Wake on LAN
Linux and UNIX	Global hot spare	Automatic power on after power recovery
Supported Browsers	SSD read cache	Network UPS support with SNMP management
Google Chrome	NVRAM write cache (BBU-protected)	Access Right Management
Microsoft Internet Explorer	Scheduled Backup Battery Unit (BBU) learning	Batch users creation
Mozilla Firefox	Share folder/LUN with thin provisioning	Import/Export users
Apple Safari	Checksum for end-to-end data integrity	User quota management
Multilingual Support	Silence error detection and self-healing	Local user access control for CIFS/SMB and FTP
Chinese (Traditional & Simplified), Czech, Danish, Dutch, English, Finnish, French, German, Greek, Hungarian, Italian, Japanese, Korean, Norwegian, Polish, Portuguese (Brazil), Romanian, Russian, Spanish, Swedish, Thai, Turkish	Pool scrub for data verification	Domain Authentication Integration
File System	Share folder quota management	Microsoft Active Directory support
ZFS	Inline deduplication for shared folder/LUN	LDAP client
Networking	Inline compression for shared folder/LUN	Domain users login via CIFS/SMB, FTP
TCP/IP (IPv4 & IPv6)	Inline encryption for shared folder/LUN	Administration
10 Gigabit NICs with jumbo frame (LACP, Load Balance, Failover, Round Robin)	WORM (Write Once Read Many) for shared folder	Multi-window, multi-tasking based system management
Service binding based on network interfaces	Storage QoS (Quality of Service) for shared folder/LUN	Movable Icons and personalized desktop
Proxy server	Shared Folder/LUN snapshot	Smart toolbar and dashboard for neat system status display
Protocols: CIFS/SMB2/SMB3, NFS v3/NFS v4, FTP, FTPS, TFTP, HTTP, HTTPS, SSH, iSCSI, SNMP, SMTP, and SMSC	Online pool, share folder, and LUN expansion	Smart Fan control
iSER (iSCSI Extensions for RDMA)	S.M.A.R.T. Information for drives and Predictive S.M.A.R.T. Migration	SNMP (V1/V2 & V3)
Bonjour Discovery	SSD Life monitors the remaining lifespan of solid-state drives	Resource monitor
File Server	Time-Limited Error Recovery (TLER)	Network recycle bin for file deletion via CIFS/SMB, File Station and FTP
Shared folder for CIFS/SMB, NFS and FTP	JBOD ID Reinitialized	Smart file filter
File sharing across Windows, Mac, and Linux/UNIX		Comprehensive logs (events & connection)
Windows ACL		Syslog client management
		System settings backup and restore
		Command Line Interface (CLI)

ES1686dc

Enterprise ZFS ES1686dc



QNAP SYSTEMS, INC.

TEL : +886-2-2641-2000 FAX: +886-2-2641-0555 Email: qnapsales@qnap.com

Address : 3F, No.22, Zhongxing Rd., Xizhi Dist., New Taipei City, 221, Taiwan

QNAP may make changes to specification and product descriptions at any time, without notice.

Copyright © 2019 QNAP Systems, Inc. All rights reserved.

QNAP® and other names of QNAP Products are proprietary marks or registered trademarks of QNAP Systems, Inc.

Other products and company names mentioned herein are trademarks of their respective holders.



TELSA Mayorista

Tels.: (55) 5740 4630 / (55) 5740 2142
www.telsa.com.mx • ventas@telsa.com.mx
Oriente 65-A No. 2848, Col. Asturias,
Del. Cuauhtémoc, CDMX, México

Netherlands (Warehouse Services)

Email: nlsales@qnap.com
TEL: +31(0)107600830

China

Email: cnsales@qnap.com
TEL: +86-400-028-0079

Thailand

Email: thsales@qnap.com
TEL: +66-2-0058588

Japan

Email: jpsales@qnap.com
FAX: 03-6435-9686

US

Email: usasales@qnap.com
TEL: +1-909-595-2782

India

Email: indiasales@qnap.com

Germany

Email: desales@qnap.com

France

Email: frsales@qnap.com



51000-024636-RS
201905 (EN) A